

NHAP

WE ARE

SPECIALISTS IN ELECTRICAL
AND AUTOMATION PRODUCTS,
SYSTEMS AND SOLUTIONS



NHP ELECTRICAL ENGINEERING PRODUCTS



MELBOURNE, AUSTRALIA

CONTENTS

NHP Electrical Engineering Products	6	Our Business	
NHP Values	7	NHP Solutions City	30
NHP Growth	8	Agriculture, Forestry & Fishing	32
NHP Foundations	12	Mining	33
NHP History	14	Manufacturing	34
		Utilities	35
Our Capabilities		Commercial Construction	36
Easy To Do Business With	16	Heavy & Civil Engineering & Construction	37
NHP Locations	18	Defence	38
Local Knowledge, Global Experience	19	Renewable Energy	39
Customer Support & Training	20	NHP Integrated Product Solutions	40
Value Add and Distribution	22	Product Segments	42
World's Best Products	24	Skill Cultivation	48
Mobile Technology	26	The Future	50
Sustainability	28		

WE CUSTOMISE ELECTRICAL SOLUTIONS

With close to 50 years of electrical and engineering industry excellence, and driven by a team of over 800 quality personnel, NHP Electrical Engineering Products Pty Ltd is a 100% Australian owned and operated market leader.

NHP specialise in motor control, power distribution and automation systems and offer the Australasian market the complete industrial electrical and automation solutions package. With 24 branches and 25 regional locations throughout Australia and New Zealand, our strong customer focus promises to meet any of your needs on time and within budget.

While NHP go to market with an impressive 75,000 line items, we are much more than a component supplier. NHP source the highest quality products from leading global suppliers, and customise these into solutions for the local market, providing a complete fit to purpose systems and solutions service.

At NHP we have a strong customer focus and we look to provide the right product and product solutions for your requirements and applications, all at a competitive price. We value, care and assist you by offering 24/7 on-call service and support all year round, so you can be safe in the knowledge that we are always there, when you need us.

NHP employs a highly skilled team of professionals that are equipped with comprehensive product knowledge and are committed to excellence.

OUR VALUES ARE YOUR GUARANTEE

Passion for Customers

Without customers we have no business, so we are passionate about everything we do for them. We service our customers' needs 24 hours a day, 7 days a week, 365 days a year



Energy

An energetic "can and will do" attitude and approach. Enthusiasm is infectious and we look to provide this in all aspects of our business and our customers' business



Adaptiveness to Change

If we don't adapt, we wither then die. While we have adhered to the same values and service objectives since day one, we also have adapted to the changing face of our industry and the industrial world, and we look to help our customers prosper as a result

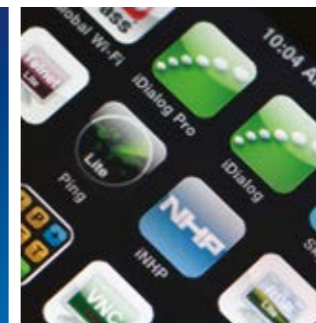

Integrity

We do what is right for our customers, our staff, our industry and our community



Consistency

We provide our customers with what they want, when, where and how they want it, for today, tomorrow and into the future



Commitment to Performance

We aim to provide products and solutions on time, in full, every time. Our customers can expect to receive service above their expectations in everything we do

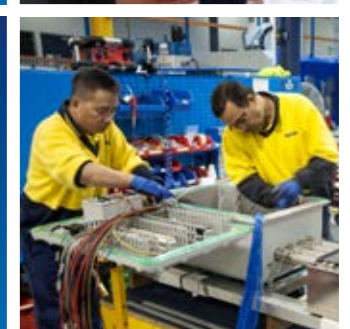

WE GROW WITH YOU

ANNUAL TURNOVER	> \$400 M
EMPLOYEES	> 800
BRANCHES	24
REGIONAL LOCATIONS	25
STOCKED LINES	15,000
MARKETED LINES	75,000
DAILY LINE ITEMS DESPATCHED	> 5,500
DELIVERED IN FULL ON TIME	> 95 %
DAILY INVOICES ISSUED	> 1,500
CUSTOMER BASE	> 12,000
AUSTRALIAN OWNED	100 %

\$400m

800

25

100%

75k

95%

THE FUTURE
BEGINS BY
ACKNOWLEDGING
OUR HISTORY

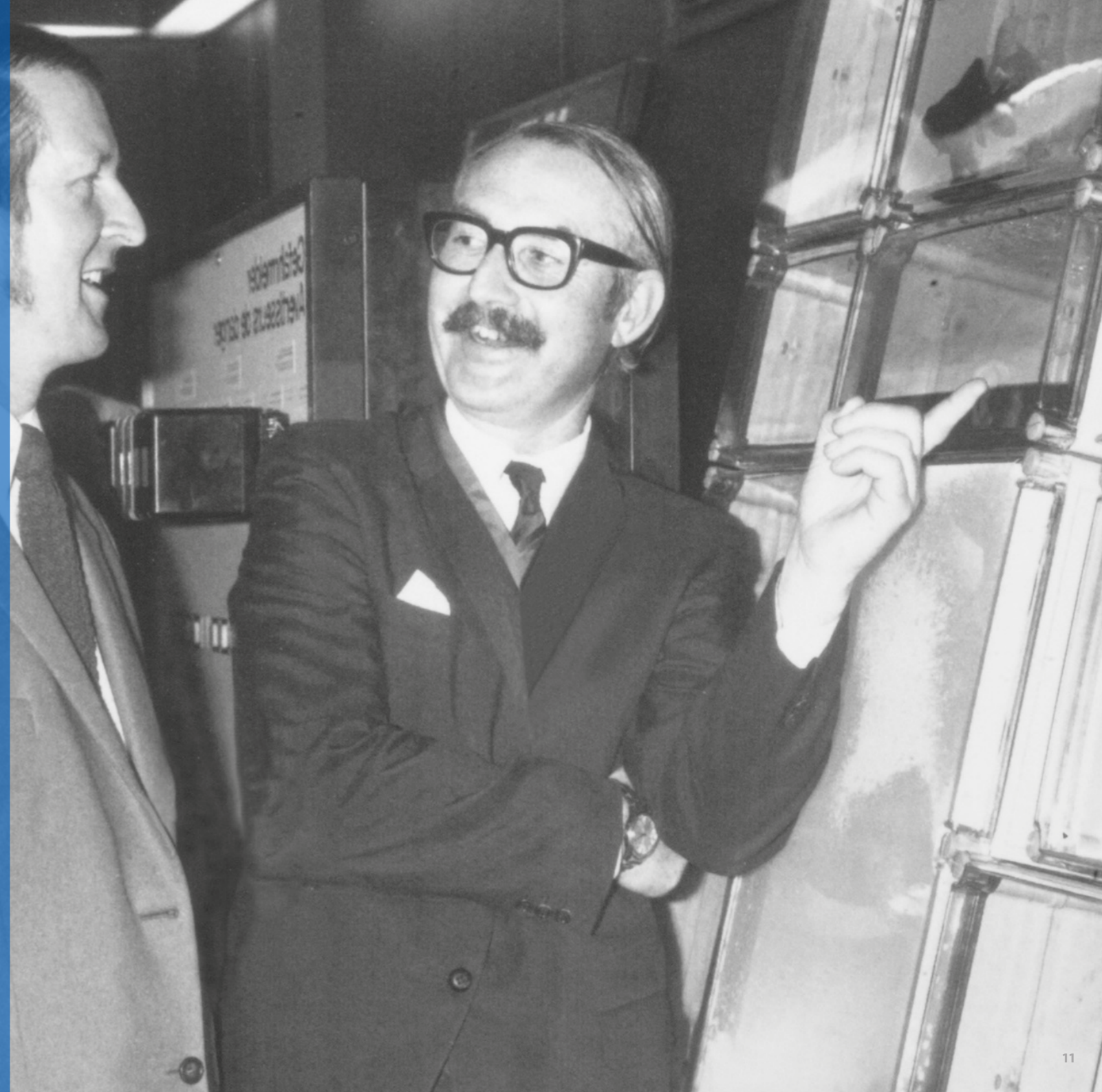

WE ARE LOCAL

NHP was built on strong foundations by having an attitude and culture that says and shows NHP is in the customer's corner.

When founder Nigel Hugh Peck first opened the doors to NHP in 1968 with a staff of just 17, he was determined to create a 100 per cent Australian-owned company focused on providing the best service and highest level of quality products.

With foundation brands including Sprecher + Schuh on board, NHP's initial Motor Control product offering lay the foundations to help NHP become the leading provider in Australasia in industrial electrical and automation products, systems and solutions that it is today.

Nigel oversaw NHP's progression and development until his retirement in November 2002, where he remained on as the

Chairperson and Director of NHP Holdings Pty Ltd, the sole owner of NHP.

Much admired for his successes within NHP, Nigel's services to the electrical industry reach far greater than the company itself and in 2004 he received national recognition for his work in the electrical industry by becoming a Member of the Order of Australia (AM).

In May, 2013, Nigel officially retired from his position as Chairperson of NHP Holdings but remains on the board as a Director, ensuring the organisation remains a proudly Australian owned company committed to serving the electrical industry – just as it was the day it began over 45 years ago.

Nigel is now enjoying his retirement on the Mornington Peninsula in Victoria.



Founder
Nigel Hugh Peck

WE HAVE HISTORY



01 1968-1972

- NHP commences operations
- Motor control products - Contactors and Overloads
- NHP holds first Exhibition



02 1978-1983

- Power Distribution - MCCBs and ACB assembly
- Control and panel products



03 1993-1998

- National Distribution and Manufacturing Centre opens
- Safety Products, VF Drives, Automation Systems
- New Zealand commences operations



04 2008

- Celebrating 40 years



Rockwell Automation

05 2009-2011

- Partnership with Rockwell Automation



06 2012-2015

- Introduction of Medium Voltage
- NHP Sustainability Centre opens

WE ARE EASY TO DO BUSINESS WITH

At NHP we're solely committed to serving the needs of our customers in the industrial electrical industry. From concept design through to installation and after sales service, we are confident we have the experience and expertise to exceed your expectations and ensure you get the best result for your project. How? Well, put simply, we're easy to do business with. Combining Partnerships, Agility, Knowledge and Scalability, NHP offer 100% Australian owned service that forms the ultimate choice in our industry.

SCALABILITY

With all the scale of a large multi-national company, NHP maintain a premium level of customer service and attention to detail no matter how big or small your project. Be it our 850+ expert staff, our 50+ branch and regional locations, or our extensive network of global suppliers, when you deal with NHP you will receive all of this combined knowledge and expertise in an 'easy to do business with' solutions with a local focus.

KNOWLEDGE

If your industrial electrical application demands a specialist team of trained project management, design and engineering professionals, then NHP is the ultimate choice. Bringing together 45 years of electrical industry experience, NHP's expert team promises to deliver customisable solutions from concept design through to installation and project management.

AGILITY

At NHP we understand your project needs and know that these needs can often change throughout the life of a project. With a seamless combination of local and technical support and a network of global suppliers, NHP have the agility to provide real-time solutions that are backed by around the clock service and support for not only the life of a project but any future needs as well.

PARTNERSHIPS

When you choose NHP you gain a valuable industry partner. You gain access to an exclusive network of quality global suppliers who together with NHP's 50+ branch and regional locations across Australia and New Zealand, can achieve an engineered solution for your industrial electrical application. A partnership with NHP promises to last the life of current and future projects, working together with you to offer complete trust, assurance and peace of mind.



WE ARE LOCATED WHERE YOU ARE



WE HAVE LOCAL KNOWLEDGE & GLOBAL EXPERIENCE

No matter how good a product may be, it is nothing without dedicated people to support that product.

NHP's philosophy of 'people doing business with people' has always rung true, and today NHP has the most extensively located team in the industry, made up of 850+ dedicated staff that are on call, easy to access, and are importantly experts in their own right.

This highly skilled team do not simply rely upon our market leading quality product range to satisfy your individual needs, but instead works relentlessly with you to deliver a solution so as to maximise your project success.

Furthermore, as the authorised Rockwell Automation distributor in our designated areas within Australia and throughout all of New Zealand, NHP has dedicated technical sales and support staff employed to service the needs of our Automation customers.

Our partnership with Rockwell Automation offers our customers and the industry in general, a powerful value proposition in terms of representation, stock availability, plant optimisation opportunities and access to industry experts to assist in every requirement that involves power, energy, control systems and solutions.

The availability and easy access to NHP and Rockwell Automation's expertise, combined with our extensive local stockholding and sound processes, are each potentially empowering factors which will give customers access to a holistic approach across their automation, industrial switchgear, training and commissioning business requirements, for complete peace of mind.

WE ARE ALWAYS THERE FOR YOU

24/7 CUSTOMER SUPPORT AND TRAINING

To support our range of quality products NHP also offer a wide range of service and training options including technical support, field service and maintenance contracts, repair services and training.

These services are delivered by both NHP qualified technicians and the expertise of our supply partners and can provide: remanufacturing and extended warranty, parts management agreements, online and phone support, instructor led training and assessments, field service and assessments, drive start-up and network services, conversions retrofits and upgrades as well as condition monitoring audits and analysis.



WE PROVIDE TAILORED VALUE ADD SOLUTIONS

NHP prides itself on being able to provide customers with tailored solutions that suit their individual needs. Whilst we have significant stockholdings and expertise at all our locations throughout Australia and New Zealand, the purpose of our National Manufacturing and Distribution Centre in Laverton, Melbourne is to develop these solutions through manufacturing, assembly, servicing and design and engineering.

SIZE

Warehouse 7,000 m²
Manufacturing 5,000 m²

OPERATING HOURS

6.00am - 11.30pm, Monday-Friday

STOCKHOLDING

Approximately 15,000 stocked lines

ITEM THROUGHPUT

Approximately 5,500 per day
(6,000 lines throughout Australasia)

FACTS

Orders released for picking before
3.00 pm are despatched the same day.

Strives to achieve 95% 'delivery in full, on time'.



WE ONLY CARRY THE WORLD'S BEST PRODUCTS

In line with our customer promise of safety, all NHP products are compliant with applicable local and international standards. We have a dedicated team that conducts regular proactive quality control checks to maintain product performance and consistency as well as ensure the highest level of safety.

As well as this, NHP is responsible for designing and developing products and product systems to satisfy the requirements of the Australian and New Zealand markets.

Integral to the success of NHP is our vast global network of Supply Partners that enable us to bring the world's best products and solutions to the local market. With over 50+ Supply Partners sourced from across the globe, NHP are able to deliver on our customer promise, providing what you want, when where and how you want it.



WE UTILISE TECHNOLOGY TO PROVIDE YOU INFORMATION AT YOUR FINGERTIPS

While having expert people and quality products are vitally important to NHP, if we are going to live and breathe our mantra of being 'easy to do business with', then we need to have the right information available and more importantly, have it easily accessible.

With this in mind, we are constantly looking to develop new digital initiatives and tools that look to make your life easier. Be it product selection apps, NTU training modules, easy access to NHP's literature library or simply opening up the communication gateway through social media or live chat, our goal is to help you tackle the varied challenges our industry can throw your way.



NHP ECATALOGUES

The NHP eCatalogues App offers a convenient way to access all of your favourite NHP Literature in the one handy location. Through this easy to navigate and simply designed App, you will have complete access to NHP's online library.



NHP CONTACTOR SELECT

Selecting contactors and overloads for three phase electric motors is made easy with this Contactor Select App from NHP.



NHP VSD SELECT

NHP's VSD Selector App makes selecting Variable Speed Drives (VSD) easier than ever before!



NHP SURGE SELECT

Selecting surge diverters to protect an installation in accordance with Australian AS/NZS standards is made easy with this Quick Surge Select App.



WE PROMOTE A SUSTAINABLE FUTURE

A major push towards more sustainable practices by many in the industrial electrical industry is now clear for all to see in today's environment. Learning to use energy smarter to reduce our consumption and increase profitability is now a key consideration in all applications.

With this in mind, NHP has designed and constructed our very own Sustainability Centre - located at our existing National Manufacturing and Distribution Centre in Laverton, Melbourne.

The Centre utilises cutting edge technology and houses equipment which enables us to conduct research and development, test new products and look closely at ways we can effectively introduce and manage sustainable practices.

The Centre is driven by power generated from Solar Panels and houses an interactive display allowing visitors a close-up view of a range of sustainable energy technologies which currently include:

- Solar photo-voltaic systems
- Grid interactive systems
- Dual axis solar tracker, and
- Energy Management and Control Systems

Our aim is to remain at the forefront of the industry, as leaders in providing alternative energy solutions for commercial and industrial applications.

NHP's Sustainability Centre highlights our commitment to encourage sustainable practices across all facets of the workplace.

NHP also recently installed 390 x 250W solar panels on the roof of the Laverton Facility totalling 97.5kW installed power.

With five three phase inverters and a Rockwell Automation based monitoring and control system, this solar install is expected to offset 25% of the site's power consumption and, in conjunction with our recent manufacturing lighting upgrade, is expected to pay for itself in five years, after that saving \$1-3M over its 20 year life.



WE KNOW YOUR INDUSTRY

NHP Solutions City is an interactive model of NHP's products and services that maps out how they each contribute to the beating heart of modern day cities.

Bringing to light all matter of domestic, commercial and industrial processes that make up a city and its various functions, NHP Solutions City looks to showcase our ability to customise a solution to suit the various industry requirements.

Explore the NHP Solutions City for yourself and you might be surprised with what you find!

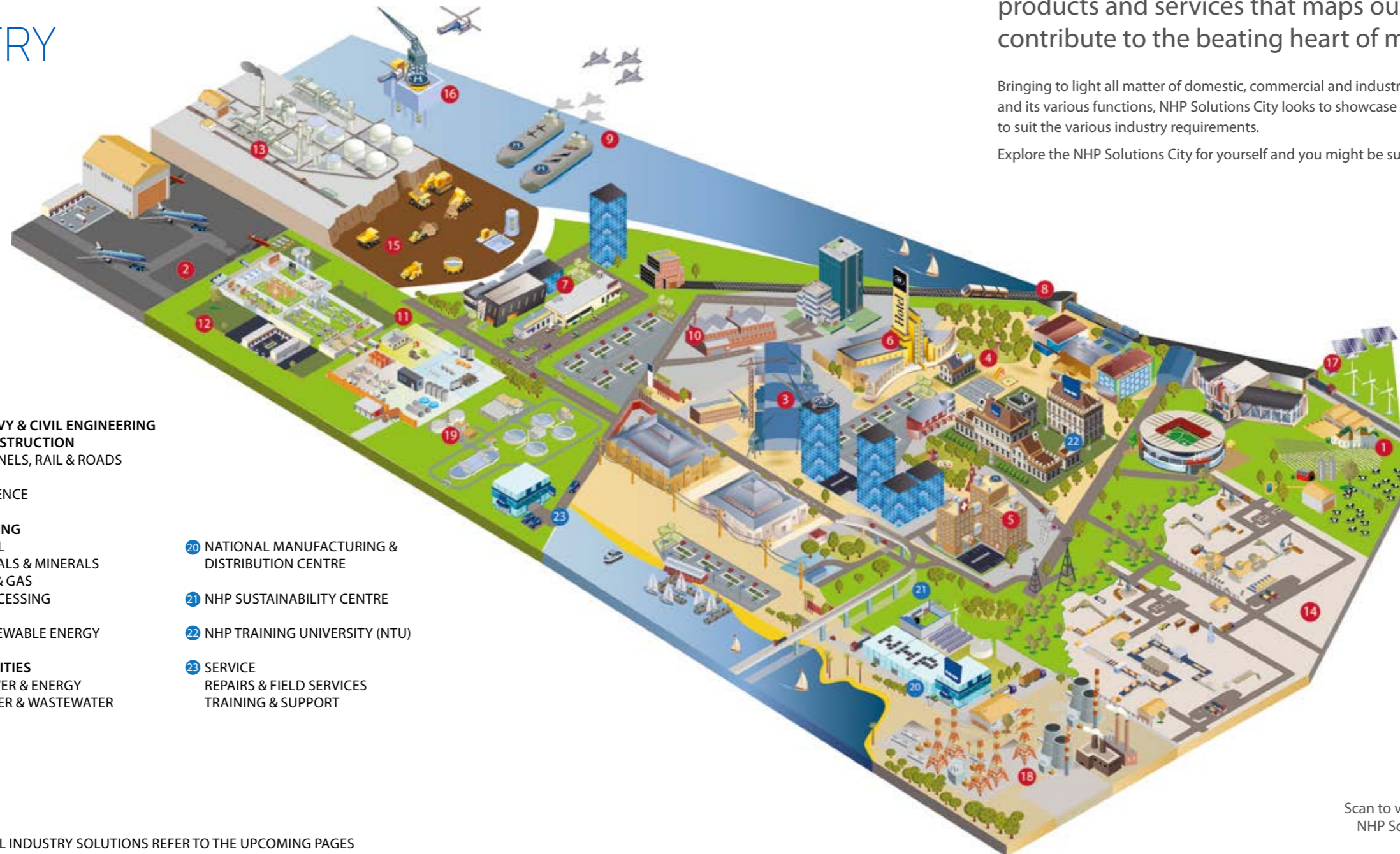

1 AGRICULTURE, FORESTRY & FISHING

COMMERCIAL CONSTRUCTION

- 2 AIRPORTS
- 3 COMMERCIAL BUILDINGS
- 3 DATA CENTRES
- 4 EDUCATIONAL FACILITIES
- 5 HOSPITAL & HEALTH CENTRES
- 6 HOTEL
- 7 RETAIL

MANUFACTURING

- 10 CEMENT, LIME, PLASTER & CONCRETE
- 11 FOOD & BEVERAGE
- 10 GLASS
- 12 PACKAGING
- 13 PETROLEUM & CHEMICALS
- 10 PHARMACEUTICALS
- 14 PULP & PAPER
- 10 TEXTILES
- 14 WOOD AND TIMBER

HEAVY & CIVIL ENGINEERING CONSTRUCTION

- 8 TUNNELS, RAIL & ROADS

- 9 DEFENCE

MINING

- 15 COAL
- 15 METALS & MINERALS
- 16 OIL & GAS
- 13 PROCESSING
- 17 RENEWABLE ENERGY

UTILITIES

- 18 POWER & ENERGY
- 19 WATER & WASTEWATER

- 20 NATIONAL MANUFACTURING & DISTRIBUTION CENTRE

- 21 NHP SUSTAINABILITY CENTRE

- 22 NHP TRAINING UNIVERSITY (NTU)

- 23 SERVICE REPAIRS & FIELD SERVICES TRAINING & SUPPORT

FOR MORE INFORMATION ON OUR INDIVIDUAL INDUSTRY SOLUTIONS REFER TO THE UPCOMING PAGES

Scan to view the interactive NHP Solutions City online



AGRICULTURE, FORESTRY & FISHING

As the demand for agriculture increases throughout Australia and New Zealand, manufacturers are faced with the challenge of continuous productivity improvement.

Now, more than ever, it is crucial for your operation to run efficiently and reliably in order to remain competitive and profitable. At NHP we offer the Agriculture industry total value solutions for their specific application needs.

From Automation & Process Control, Energy Management, Drive Control, Power Protection, Enclosure Systems, and Safety, NHP can customise industry specific value solutions for your applications.



KEY PROJECTS INCLUDE:
Nelson Pine Industries
MSF Sugar

MINING

The mining industry is constantly facing new and more complex challenges to find a competitive advantage – be it the reduction of unplanned shutdowns, improved asset management and energy efficiency, reliability, productivity or quality. At NHP we are aware of the critical challenges that need to be overcome to be successful within this important industry sector and look to provide the answers through standardised engineered product solutions to address your needs. NHP incorporates the world's best and most extensive range of low and medium voltage, Ex and non Ex products into tailored mine, focused application solutions, designed to satisfy all your operational needs and ensure efficient and reliable operation across the board.

KEY PROJECTS INCLUDE:

Roy Hill
Wiggins Island Coal Export Terminal (WICET)
Port of Newcastle (NCIG)
Mungari Gold
Ichthys (LNG)



MANUFACTURING



KEY PROJECTS INCLUDE:

- AACo Northern Beef processing facility
- Refuel International
- Blue Lake Milling
- Knauf Plasterboard Australia



NHP has become renowned in the electrical industry for our manufacturing capability – a sentiment that clearly reflects the market’s increasing demand for ‘value-added’ products. At NHP we have a team dedicated to Manufacturing & Assembly who can build standard NHP products as well as customise manufactured products in accordance with customer specifications.

This flexibility offered in the manufacturing process emphasises our clear customer focus.

UTILITIES

Electricity, gas and water are the essential inputs that feed the production cycle of almost all other industries. In a modern day climate where limited water resources and concern regarding the environmental impact of electricity production is real, innovation is the key focus for success.

In turn, NHP is proud to offer a range of innovative solutions to address the many challenges that our customers may face. NHP keeps up to date by attending international trade fairs and is involved in various industry associations to bring the world’s best practice to our doorstep. With this knowledge and cutting edge technology, NHP helps its customers achieve the innovation they need to stay ahead.

KEY PROJECTS INCLUDE:

- Taupo District Council wastewater facility
- Cairns Regional Council water and wastewater facility
- Mount Mercer wind farm



CARLTON FOOTBALL CLUB TRAINING FACILITY

COMMERCIAL CONSTRUCTION

NHP provides electrical distribution, energy management and control systems, and power quality products and solutions to suit Australasia's construction industry

KEY PROJECTS INCLUDE:

- Sydney Cricket Ground
- Adelaide Oval
- Stonefields Primary School



BLIGH ST, SYDNEY

HEAVY & CIVIL ENGINEERING CONSTRUCTION

With over 45 years of knowledge and experience, NHP are proud providers of heavy duty solutions for the heavy and civil engineering construction sector.

We understand that the larger scope of your heavy or civil engineering construction project not only calls for increased focus on product selection, but other compliance requirements such as government restrictions and safety regulations.

The ability to overcome such challenges can be the difference between success and failure and partnering with NHP unlocks an extensive range of low and medium voltage products supported by expert staff to enable a customised solution.

Complementing our heavy duty product range, NHP also offer a complete range of technology systems specifically designed to monitor equipment and achieve higher productivity as well as increase efficiency and safety.

KEY PROJECTS INCLUDE:

- Reliance Rail – NSW

Whether it is iconic high rise developments or purpose built single level function buildings, office accommodation or a retail or shopping centre, with over 45 years' experience, NHP understands what is required to meet your expectations. We know that your project relies on safety, continuance of power to operate and has stringent design criteria to meet.

This is where NHP is able to offer expertise by way of our Major Projects and Application Engineering teams, both who are specialists in the field, ensuring theoretical design and specification is met with an engineered NHP solution.

When there is consequence for power loss at a facility, NHP is able to provide a fit for purpose power distribution, energy management, or SCADA solution to suit any infrastructure application.



RELIANCE RAIL - NSW

DEFENCE



KEY PROJECTS INCLUDE:
Royal New Zealand Navy

When it comes to the Defence industry, NHP are your trusted providers of electrical products and solutions. With the resources to provide local and reliable service and stock across Australia and New Zealand, our complete product offering promises to satisfy your Defence application requirements. Our ability to customise solutions that comply with all relevant standards and certifications, combined with proven testing for seismic and shock, allows a level of confidence that delivers results.

If minimising downtime and electrical outages is your focus, NHP have a range of products to suit, including Explosion Proof Electrical Equipment for use in Hazardous Areas. These products include Lighting (fixed and portable), plugs and sockets and control panels. Partner with NHP to provide the best electrical protection in refuelling or munitions situations for Defence personnel.

RENEWABLE ENERGY

With an increasing focus on the state of global warming and the requirement to decrease our carbon footprint, the use of renewable energy is becoming a popular phenomenon. Our partnerships with many of the industry's best suppliers from around the world means that NHP offer a large selection of products and solutions tailored towards renewable energy applications including Solar and Wind. From high DC rated protection and switching devices, solar panel control and monitoring products through to a range of inverters and power factor correction, NHP has an extensive offering.

KEY PROJECTS INCLUDE:

- CPV Solar Installation - Mildura
- Crown Lift Trucks
- OzPack Industries
- The Vines of Reynella - Adelaide

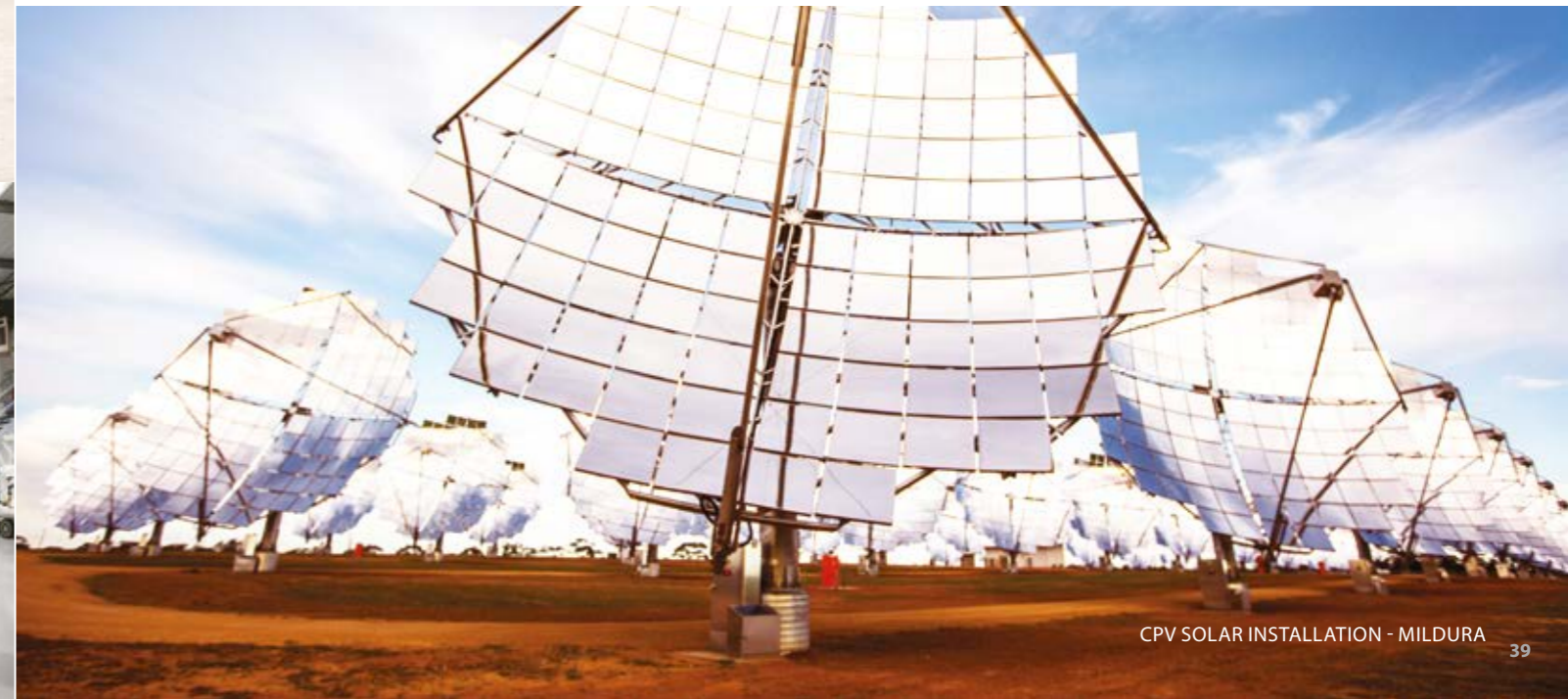

WE INTEGRATE PRODUCTS AND PROVIDE SOLUTIONS

REQUIRED COMPONENTS

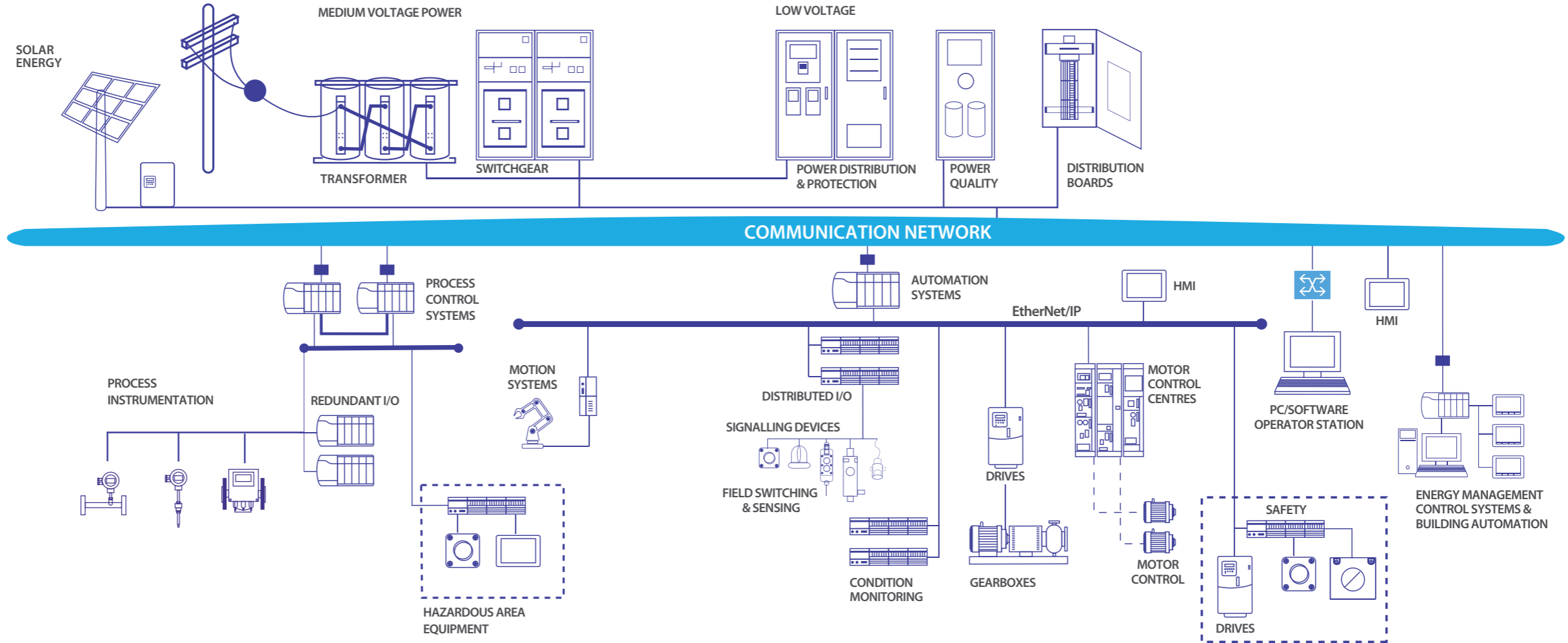
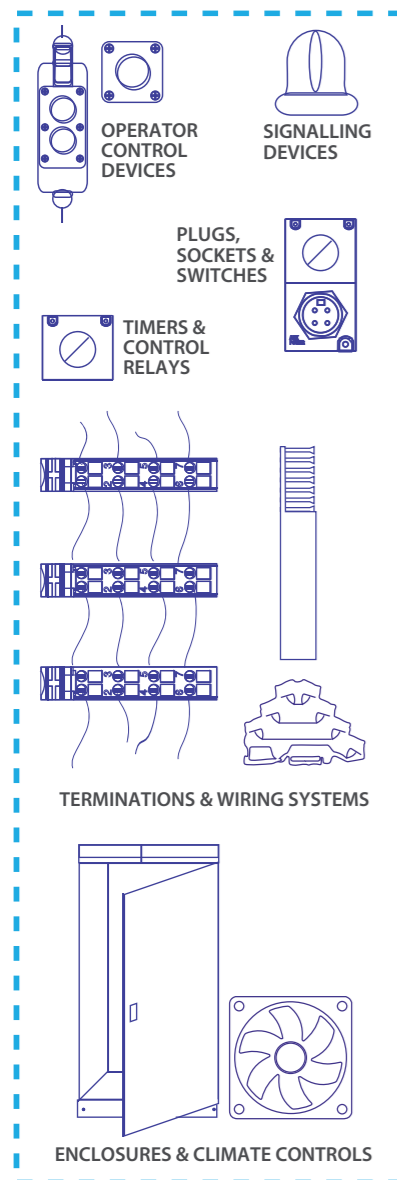

SERVICES & TRAINING



- > REPAIRS
- > FIELD SERVICES
- > TRAINING & SUPPORT
- > CONTRACTS & CUSTOMER SUPPORT
- > ENGINEERED SOLUTIONS



To assist customers in finding what they want, we classify our extensive product range into the following categories.



AUTOMATION SYSTEMS

Our vast automation product range can provide a completely integrated automation solution, for both the factory and process automation industries, that can be delivered with our Integrated Architecture platform.

- MES Software
- Visualisation Software
- Process Control Systems
- Modular Programmable Controllers
- Micro Controllers and Smart Relays
- Distributed I/O Systems
- Motion Controllers and Servo Drives
- Operator Panels and Touch Screens
- Industrial Computers
- Networking and Radio Communications



PROCESS CONTROL SYSTEMS

PlantPax™ is the process automation system from Rockwell Automation with all the core capabilities expected in a world-class distributed control system (DCS). The system is built on a standard-based architecture using Integrated Architecture components that enable multi-disciplined control and Premier Integration with the Rockwell Automation Intelligent Motor Control portfolio.

- Single configuration environment with integrated database
- Common tag structure
- Standardised mimic layouts
- A library of reusable control objects
- Common Alarms & Events display
- Security Management
- Audits manage and record system changes
- Centralised software licence management



MOTOR CONTROL AND DRIVES

NHP offers conventional motor starting and protection products as well as advanced electronic starting, controlling and protection products to suit fractional horsepower motors through to large frame main drive systems. NHP also offers customised motor starters across the entire range.

- AC Contactors
- DC and Traction Contactors
- Standard Starters
- Customised Starters
- Overload Relays
- Thermistors
- Electronic Motor Protection Relays
- Motor Protection Circuit Breakers
- Soft Starters
- Variable Speed Drives
- MV Variable Speed Drives
- Liquid Resistance Starters



POWER DISTRIBUTION AND PROTECTION

NHP provides Australasia's widest range of low voltage power distribution and protection products supplied as components or as part of a manufactured solution. Circuit protection against current overloads up to 6300A is available together with a wide range of surge and arc protection, switching products and power supplies.

- Distribution Boards
- Circuit Breakers
- Switches
- Chassis Systems and busbars
- Fuses and Fuse gear
- Earth Leakage Protection
- Arc and Surge protection
- Panelboards and loadcentres
- Chassis Systems and busbars
- Isolators and Transfer Switches
- Power Supplies and transformers



POWER QUALITY

NHP's Power Quality products and systems provide solutions for power factor correction and harmonic mitigation. To meet specific customer requirements, this group of products are generally customised at our manufacturing centre in Laverton, Victoria.

- Power Factor Correction Systems
- Power Factor Correction Regulators
- Power Capacitors
- Harmonic Filters
- EMC Filters
- DV / DT Filters
- Sine Filters
- Line Filters



ENERGY MANAGEMENT CONTROL SYSTEMS AND BUILDING AUTOMATION

NHP can provide Energy Management Metering and Software solutions that monitor and record energy information so operators can identify consumption trends and take corrective actions. Real-time measurements of these electrical parameters, such as voltage variations or distortions, may have alarm thresholds set to warn managers if preset limits are reached. These real-time measurements also allow site managers to anticipate overload conditions that could, for example, trip a circuit breaker. NHP can provide a wide range of products to complement any Energy Management Solution.

- Energy Meters
- Power Analysers
- Industrial PC's
- Industrial HMI's
- Control Systems
- Energy Management Software



ENCLOSURES & CLIMATE CONTROL

NHP has a complete range of mild steel, stainless and plastic enclosure options in a variety of IP ratings and configurations including modular switchboard systems. To complement NHP's enclosure systems, a wide range of climate control solutions are also available.

- Modular Switchboard Systems
- Insulated Plastic Enclosures
- Mild Steel Enclosure Systems
- Stainless Steel Enclosure Systems
- Mild Steel Air Conditioners
- Stainless Steel Air Conditioners
- Thermostats
- Anti-condensation Heaters
- Heat Exchangers (Air/Air, Water/Air)
- Grills and Filters
- Fans



TERMINATION & WIRING SYSTEMS

NHP has a wide range of screw and screw-less terminals, terminal accessories (such as a DIN rail and jumper pins), cable ducting and pre-wired cable looms for Allen Bradley automation systems which significantly reduces labour intensive wire termination.

- Cable Duct
- Din Rail
- Cable Glands
- Terminals
- Pre-wired cable looms



TIMERS & CONTROL RELAYS

NHP offers a range of control relays and timers that can be used in conjunction with a conventional automation system to switch higher loads or in stand alone applications where the only basic single function control is required.

- Time Delay Relays
- Monitoring Relays
- Time Clock Switches
- Solid State Relays
- Single Loop Controllers
- Electromechanical Relays



FIELD SWITCHING & SENSING

The automation system relies on information from the field to control the process. NHP's switching and sensing suite of products cover all field sensing requirements including standard and hazardous area applications.

- Limit Switches
- Pressure Switches
- Photoelectric Sensors
- Proximity Sensors
- Level Sensor and Float Switches
- Temperature Sensors
- Flow Switch and Sensors



PROCESS INSTRUMENTATION

Whatever you need to measure: we have the right solution for every task. Our partnership with Endress + Hauser provides access to a comprehensive portfolio of instruments, services and solutions that will help you to operate your processes in a safe, reliable, environmentally compatible and cost effective manner.

- Flow Measurement
- Level Measurement
- Liquid Analysis
- Pressure Measurement
- Temperature Measurement



OPERATOR CONTROL DEVICES

Most processes, even if automated, still require some manual control and NHP provides a complete range of control products and systems for this purpose.

- Pushbuttons
- Cam Switches
- Pendant Systems
- Trip Wire Switches
- Foot Switches



SIGNALLING DEVICES

With an extensive range of audible and visual signalling devices, NHP provides solutions for hundreds of applications, be it general safety warning, process control, fire or evacuation.

- Xenon and LED Beacons
- Modular Stack Lights
- Sounders
- Sirens
- Buzzers
- Hooters
- Bells



SAFETY

NHP offer a large variety of quality safety products that meet international standards, with products ranging from simple emergency stop switches, light curtains, and safety monitoring relays all the way up to fully integrated safety PLC systems and SIL3 rated Safety Critical Shutdown systems.

- Safety Services
- Safety Relays and Controllers
- Safety Programmable Controllers
- Safety Critical Shutdown and Control System
- Mechanical Interlocks
- Non-contact Interlocks
- Safety Mats and Edges
- Light Curtains and Laser Scanners
- Trapped Key Interlocks
- Safety Camera Systems
- Safety Contactors and Isolators



HAZARDOUS AREA EQUIPMENT

NHP provides a world class range of hazardous area equipment for explosive environments including light fittings, enclosures and terminal boxes, control stations and intrinsically safe automation products.

- Lighting
- Enclosures and Terminals
- Control and Switchgear
- Sight and Sound
- Plugs and Sockets
- Remote I/O + HMI
- Safety Devices



PLUGS, SOCKETS & SWITCHES

Divided into two distinct product ranges, NHP's plugs and sockets provide solutions for a wide range of applications and are available in a wide range of amperages and pin configurations.

- Industrial plugs & sockets
- Industrial isolating plugs & sockets



SOLAR ENERGY

With an increasing focus on the state of global warming and the requirement to decrease our carbon footprint, the use of sustainability is becoming a popular phenomenon.

NHP offers a large selection of products and solutions tailored towards renewable energy applications including Solar. From high DC rated protection and switching devices, solar panel control and monitoring products through to a range of inverters and power factor correction systems.

- Solar Panels
- Solar Distribution Boards
- Solar Inverters
- DC MCBs and Contactors
- Solar Panel String Protection and Control Boxes
- DC Cables and Connectors
- Surge Protection Devices
- Power Factor Correction Units



MEDIUM VOLTAGE

NHP are proud to bring to the market a complete range of Medium Voltage products and solutions to complement our current low voltage industrial switchgear and automation offering. From quality Medium Voltage Switchgear to long-lasting transformers and market leading substation and automation solutions, the NHP Medium Voltage offering can be customised to suit your specific design performance criteria and are not only reliable and built to last, but also ideal for the Australasian medium voltage industry climate.

- Transformers
- Switchgear
- Substation Automation Solutions



SERVICES & TRAINING

NHP has a wide range of services including technical support, field service and maintenance contracts, repair services and training. These services are delivered by both NHP qualified technicians and our supply partners including Rockwell Automation.

- Remanufacturing and Extended Warranty
- Parts Management Agreements
- Online and Phone Support
- Instructor Led Training and Assessments
- Field Service and Assessments
- Drive Start-Up and Network Services
- Conversions and Upgrades
- Condition Monitoring Audits and Analysis
- Retrofits and Miagations
- Installation and Commissioning

WE CULTIVATE SKILLS



NHP TRAINING UNIVERSITY (NTU)

NHP's Training University (NTU) has been designed to give participants the knowledge to understand industrial electrical products, delivering a combination of general knowledge about basic electrical principles and products through a consistent training method that ensures well delivered content and measurable performance.

We understand that your time is important and NTU was designed with this in mind. The NTU program is broken into individual modules and each module covers a specific topic.

There are two modules that cover basic electrical and product principles and a series of modules covering specific product groups. NHP will continually add to these modules.



To find out more about NTU, scan the QR Code or visit nhpntu.com



SAFETY STANDARDS WORKSHOP

In response to the changing landscape of International Machinery Safety Standards, NHP have designed a range of valuable Safety Standards Workshops to ensure you're on top of safety. The Safety Standards Workshops from NHP provide valuable information on the evolving machine safety industry including relevant standards including risk assessment, design process and safety categories.



ON TOUR PROGRAM

The On Tour program is a program run by NHP with support from its distribution partner Rockwell Automation. The program offers a range of FREE hands-on labs complete with detailed presentations focusing on Allen-Bradley® products.

These hands-on labs are run throughout Australia and New Zealand exposing existing and new customers to our product and solution offerings to provide them with the edge over their competitors!



To find out more about upcoming events, scan the QR code or visit nhp.com.au/events

NHP ENGSPACE

At NHP we recognise that maintaining strong personal relationships with other members of the electrical industry in conjunction with quality training is an important part of being successful.

With that in mind we have created NHP EngSpace - a free training program that aims to provide engineering professionals with easy and direct access to product technical support and ongoing technical training. Within the program, participants are also exposed to a number of great opportunities to foster their own personal network through the social and technical events held at NHP.

Your opportunity awaits...

INSTRUCTOR LED TRAINING

Ongoing training is an important component of a strategic approach to maintenance, and constantly improving human and process performance often translates into increased job productivity and overall plant profitability.

NHP offer a range of instructor led technical training courses that have been developed off the back of extensive industry experience.

Such training courses include:

- PLC Systems and Software
- Hazardous Area Equipment
- Modular Switchboard Instruction
- Drives

WE FOCUS ON THE FUTURE

The fundamentals as outlined in this brochure that NHP proudly stand by can be summarised by these key points:

- To bring the best industrial electrical and automation products the world has to offer to our customers in Australia and New Zealand
- To provide quality technical support and expertise with local application and product knowledge
- To provide information where and when our customers need it
- To provide 'value-add' product assembly to suit regional and local requirements, ensuring fit for purpose and ease of use
- To provide an 'easy to do business with' approach
- To provide significant stock holdings close to our customers, facilitating 'On Time - In Full' delivery
- To provide competitive pricing.

Many of these fundamentals applied to our business when it first started in 1968 and are as true now as they were then. However, while NHP is proud of its past, we recognise the future will always be more important than the past. With the industrial electrical and automation industries constantly evolving, the need to remain dynamic and at the forefront of technology is paramount in remaining competitive in today's marketplace.





AUSTRALIA

nhp.com.au

SALES 1300 NHP NHP

sales@nhp.com.au

VICTORIA

Melbourne

43-67 River Street
Richmond
VIC 3121
Tel +61 3 9429 2999

Laverton

104-106
William Angliss Drive
Laverton North
VIC 3026
Tel +61 3 9368 2901

Dandenong

Unit 1/80 Monash Drive
Dandenong South
VIC 3175
Tel +61 3 8773 6400
Fax 1300 647 329

TASMANIA

Hobart

29B Lampton Ave
Derwent Park
TAS 7009
Tel +61 3 6228 9575
Fax +61 3 6228 9757

Launceston

Unit 3
13-17 Merino Street
Kings Meadows
TAS 7249
Tel +61 3 6345 2600
Fax +61 3 6344 6324

SOUTH AUSTRALIA

Adelaide

36-38 Croydon Road
Keswick
SA 5035
Tel +61 8 8297 9055

NEW SOUTH WALES

Sydney

30-34 Day Street North
Silverwater
NSW 2128
Tel +61 2 9748 3444

Newcastle

575 Maitland Road
Mayfield West
NSW 2304
Tel +61 2 4960 2220
Fax +61 2 4960 2203

Wollongong

Unit 3
1 Resolution Drive
Unanderra
NSW 2526
Tel 1300 647 647
Fax 1300 647 329

Albury / Wodonga

847 Ramsden Drive
Albury
NSW 2640
Tel +61 2 6049 0600
Fax +61 3 6025 0592

ACT

Canberra

Unit 1
187 Gladstone Street
Fyshwick
ACT 2609
Tel +61 2 6280 9888
Fax +61 2 6280 9588



For more information, scan to download the NHP Catalogues App offering exclusive video content, catalogues and literature!

WESTERN AUSTRALIA

Perth

38 Belmont Ave
Rivervale
WA 6103
Tel +61 8 9277 1777

NORTHERN TERRITORY

Darwin

3 Steele Street
Winnellie
NT 0820
Tel +61 8 8947 2666
Fax +61 8 8947 2049

QUEENSLAND

Brisbane

16 Riverview Place
Murarrie
QLD 4172
Tel +61 7 3909 4999

Townsville

5 Leyland Street
Garbutt
QLD 4814
Tel +61 7 4779 0700
Fax +61 7 4775 1457

Rockhampton

1 Lawson Street
Parkhurst
QLD 4702
Tel +61 7 4927 2277
Fax +61 7 4922 2947

Toowoomba

Cnr Carroll Street and
Struan Court
QLD 4350
Tel +61 7 4634 4799
Fax +61 7 4633 1796

Cairns

Unit 2, 1 Bramp Close
Portsmith
QLD 4870
Tel +61 7 4035 6888
Fax +61 7 4035 6999

NEW ZEALAND

nhp-nz.com

SALES 0800 NHP NHP

sales@nhp-nz.com

PO Box 62-009

Sylvia Park
Auckland 1644
New Zealand

Auckland

118a Carbine Road
Mt Wellington 1060

Hamilton

78 Rostrevor Street
Hamilton 3204

Napier

126 Taradale Road
Onekawa 4110

Wellington

Unit B4, 59 Marsden Street
Melling
Lower Hutt 5010

Christchurch

27 Iversen Terrace
Waltham 8011

Dunedin

30 Fox Street
South Dunedin 9012

NHP Electrical Engineering Products Pty Ltd
A.B.N. 84 004 304 812

NHPCORPPUB 08 15 © Copyright NHP 2015



Environmentally Friendly
Printed on recycled paper



Authorised
Distributor